



WINKEL-Rollen | WINKEL Bearings

Anschraubplatten rechteckig für WINKEL-Rollen und Radiallager

WINKEL-Rollen mit Anschraubplatten sind fertige Systemelemente für schraubbare Verbindungen zwischen Konstruktion und Führungsprofil.

- alle Anschraubplatten mit eingeschweißter WINKEL-Rolle
- axiale Justierung mit Distanzsteckbleche Typ DS
- alle Anschraubplatten in brüniertem Ausführung
- Material: S235 JR

Sonderausführungen auf Anfrage.

Flange plates rectangular for WINKEL Bearings and Radial Bearings

WINKEL flange plates in combination with WINKEL Bearings are suitable for screw joints between construction and guide profile.

- all flange plates are welded with WINKEL Bearings
- axial adjusting with washers type DS
- all flange plates in burnished version
- material: S235 JR

Special designs on request.

CAD Download in 2D/3D unter www.winkel.de

CAD download in 2D/3D at www.winkel.de



Axiale Justierung über Steckbleche
Adjustment of bearings with screw-axial adjustment of plug trays





WINKEL-Rollen | WINKEL Bearings

AP A

Artikel-Nr. 212.042.000
Article no.

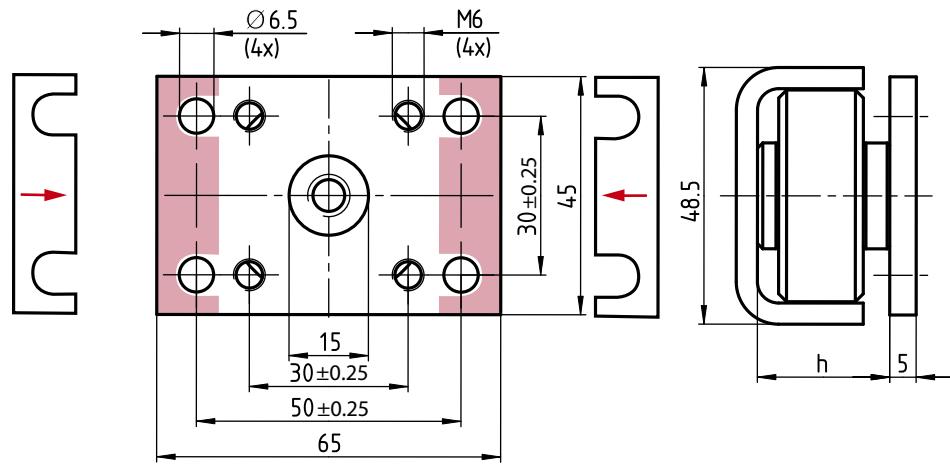

Typ Type	WINKEL-Rolle mit AP WINKEL Bearing with AP	Artikel-Nr. Article no.	Profil Profile	h [mm]	Gewicht AP Weight AP	Distanzsteckbleche Washers	
AP A	4.052 P + AP A	200.132.000	Standard A	25,0	0,10 kg	DS-A-0,5 238.026.000	DS-A-1,0 238.026.001

AP S

Artikel-Nr. 212.014.000
Article no.

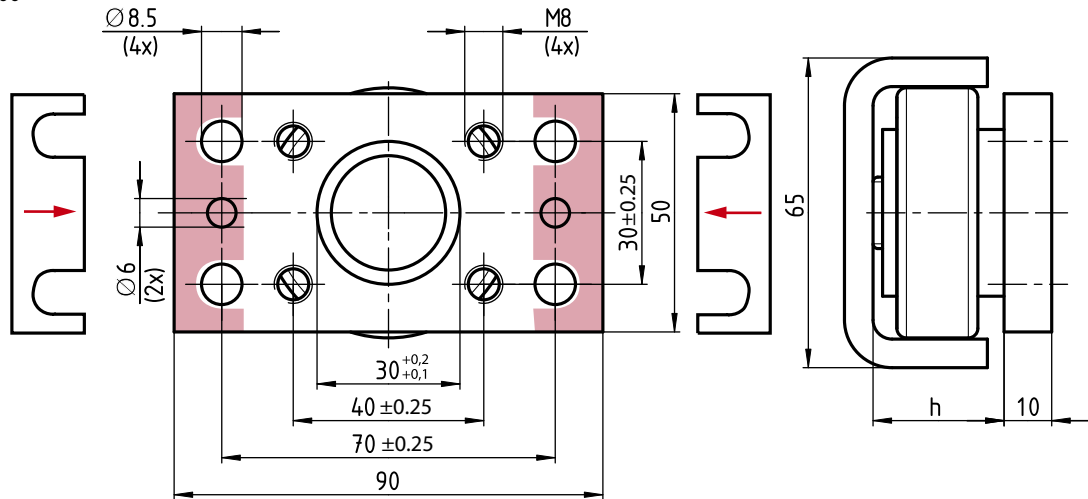

Typ Type	WINKEL-Rolle mit AP WINKEL Bearing with AP	Artikel-Nr. Article no.	Profil Profile	h [mm]	Gewicht AP Weight AP	Distanzsteckbleche Washer	
AP S	4.053 + AP S	200.071.000	Standard S	27,0	0,25 kg	DS-S-0,5	DS-S-1,0
	4.053 HT + AP S	200.024.012	Standard S	27,0		238.025.000	238.025.001



WINKEL-Rollen | WINKEL Bearings

AP 0

Artikel-Nr. 212.003.000
Article no.

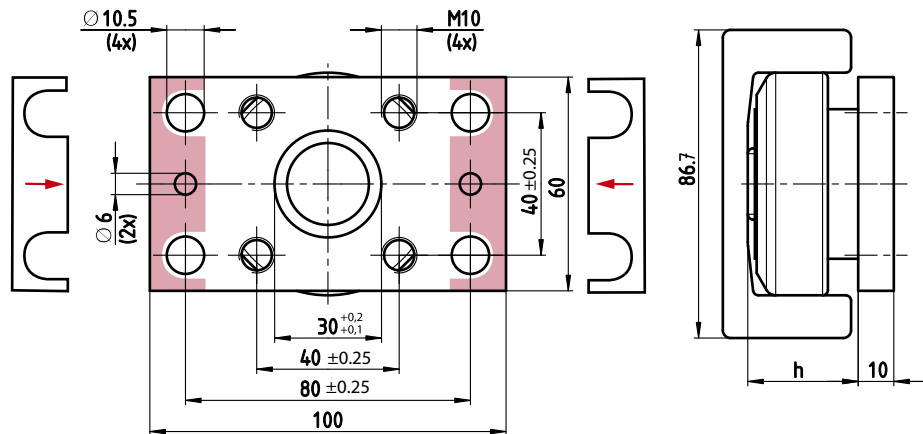

Typ Type	WINKEL-Rolle mit AP WINKEL Bearing with AP	Artikel-Nr. Article no.	Profil Profile	h [mm]	Gewicht AP Weight AP	Distanzsteckbleche Washers
AP 0	2.054 + AP 0	205.061.003	Standard 0 NbV	26,5	0,35 kg	DS-0-0,5 DS-0-1,0 238.020.000 238.020.001
	4.054 + AP 0	200.051.000	Standard 0 NbV	30,5		
	4.054 HT + AP 0	200.001.021	Standard 0 NbV	30,5		
	4.454 + AP 0	201.031.001	Standard 0 NbV	30,5 - 32,0		
	4.072 + AP 0	201.011.000	Standard 0 NbV	33,0		
	4.072 P + AP 0	200.149.000	Standard 0 NbV	33,0		
	PR 2.054 + AP 0	205.071.002	PR 0 NbV	26,5		
	PR 4.054 + AP 0	200.100.002	PR 0 NbV	30,5		
	PR 4.454 + AP 0	200.114.001	PR 0 NbV	30,5 - 32,0		
	PR 4.072 + AP 0	200.107.001	PR 0 NbV	33,0		
PR 4.072 P + AP 0	200.011.008	PR 0 NbV	33,0			

AP 1

Artikel-Nr. 212.004.000
Article no.

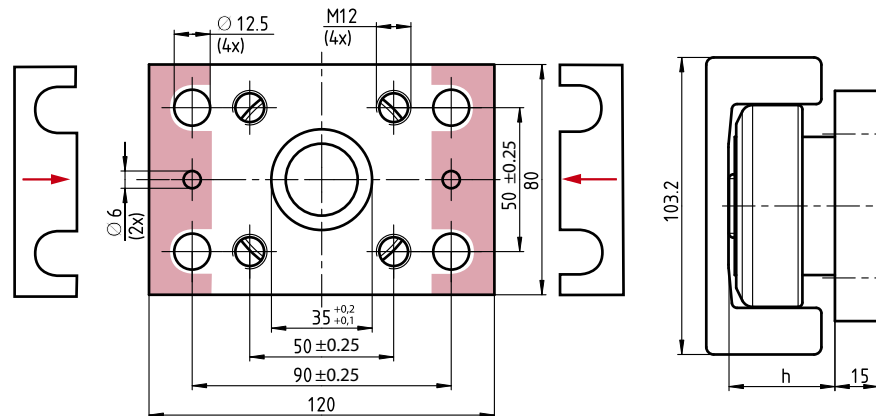

Typ Type	WINKEL-Rolle mit AP WINKEL Bearing with AP	Artikel-Nr. Article no.	Profil Profile	h [mm]	Gewicht AP Weight AP	Distanzsteckbleche Washers
AP 1	2.055 + AP 1	205.109.000	Standard 1 NbV	34,0	0,90 kg	DS-1-0,5 DS-1-1,0 238.021.000 238.021.001
	4.055 + AP 1	200.052.000	Standard 1 NbV	36,0		
	4.055 HT + AP 1	200.002.021	Standard 1 NbV	36,0		
	4.455 + AP 1	201.032.001	Standard 1 NbV	36,0 - 37,5		
	4.073 + AP 1	200.077.000	Standard 1 NbV	40,0		
	4.073 P + AP 1	200.012.005	Standard 1 NbV	40,0		
	PR 2.055 + AP 1	205.072.001	PR 1 NbV	34,0		
	PR 4.055 + AP 1	200.101.002	PR 1 NbV	36,0		
	PR 4.455 + AP 1	200.115.001	PR 1 NbV	36,0 - 37,5		
	PR 4.073 + AP 1	200.108.001	PR 1 NbV	40,0		
PR 4.073 P + AP 1	200.014.002	PR 1 NbV	40,0			



WINKEL-Rollen | WINKEL Bearings

AP 2

Artikel-Nr. 212.005.000
Article no.

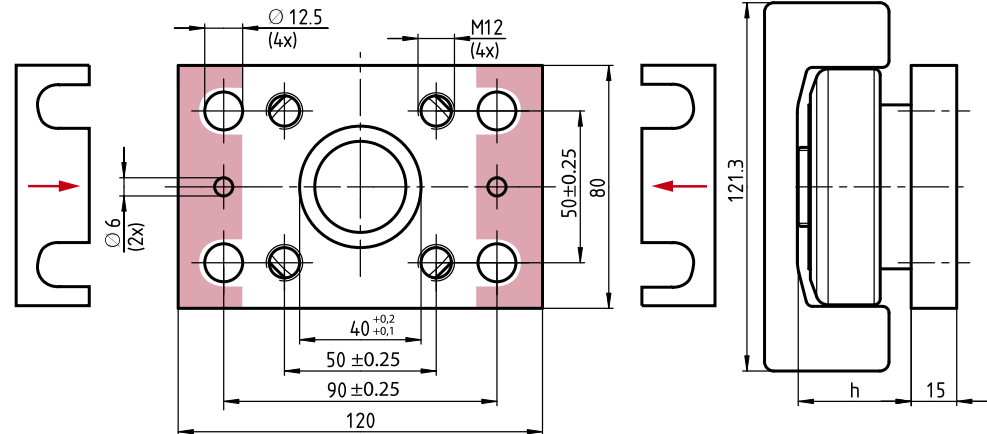

Typ Type	WINKEL-Rolle mit AP WINKEL Bearing with AP	Artikel-Nr. Article no.	Profil Profile	h [mm]	Gewicht AP Weight AP	Distanzsteckbleche Washers
AP 2	2.056 + AP 2	205.107.000	Standard 2 NbV	34,0	0,85 kg	DS-2-0,5 DS-2-1,0 238.021.000 238.021.001
	4.056 + AP 2	200.053.000	Standard 2 NbV	36,5		
	4.056 HT + AP 2	200.003.021	Standard 2 NbV	36,5		
	4.456 + AP 2	201.033.002	Standard 2 NbV	37,0 - 38,5		
	4.074 + AP 2	200.127.000	Standard 2 NbV	39,5		
	4.074 P + AP 2	200.013.008	Standard 2 NbV	39,5		
	PR 2.056 + AP 2	205.073.002	PR 2 NbV	34,0		
	PR 4.056 + AP 2	200.066.000	PR 2 NbV	36,5		
	PR 4.456 + AP 2	200.116.001	PR 2 NbV	37,0 - 38,5		
	PR 4.074 + AP 2	200.109.002	PR 2 NbV	39,5		
	PR 4.074 P + AP 2	200.148.000	PR 2 NbV	39,5		

AP 3.1

Artikel-Nr. 212.006.001
Article no.

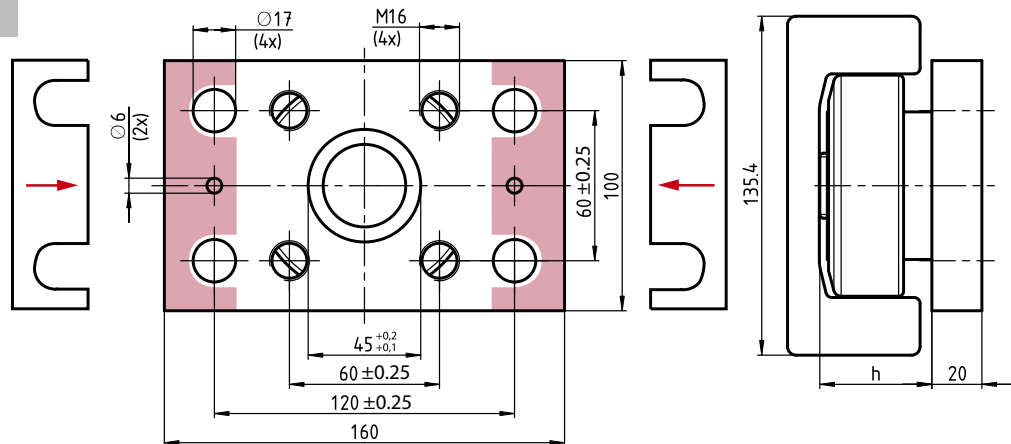

Typ Type	WINKEL-Rolle mit AP WINKEL Bearing with AP	Artikel-Nr. Article no.	Profil Profile	h [mm]	Gewicht AP Weight AP	Distanzsteckbleche Washers
AP 3.1	2.058 + AP 3.1	205.064.004	Standard 3 NbV	41,0	2,35 kg	DS-3.1-0,5 DS-3.1-1,0 238.105.000 238.105.001
	4.058 + AP 3.1	200.054.001	Standard 3 NbV	44,0		
	4.058 HT + AP 3.1	200.005.017	Standard 3 NbV	44,0		
	4.458 + AP 3.1	201.035.002	Standard 3 NbV	44,0 - 45,5		
	4.076 + AP 3.1	201.014.000	Standard 3 NbV	48,0		
	4.076 P + AP 3.1	200.015.009	Standard 3 NbV	48,0		
	PR 2.058 + AP 3.1	205.075.001	PR 3 NbV	41,0		
	PR 4.058 + AP 3.1	200.140.001	PR 3 NbV	44,0		
	PR 4.458 + AP 3.1	200.117.002	PR 3 NbV	44,0 - 45,5		
	PR 4.076 + AP 3.1	200.110.001	PR 3 NbV	48,0		
	PR 4.076 P + AP 3.1	200.015.012	PR 3 NbV	48,0		



WINKEL-Rollen | WINKEL Bearings

AP 4

Artikel-Nr. 212.007.001
Article no.

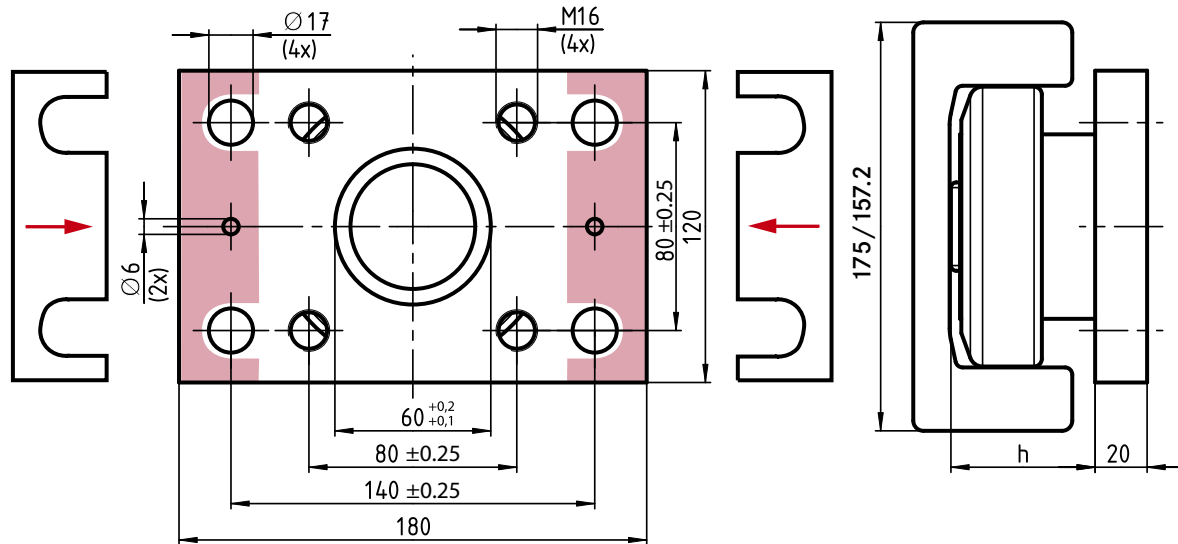

Typ Type	WINKEL-Rolle mit AP WINKEL Bearing with AP	Artikel-Nr. Article no.	Profil Profile	h [mm]	Gewicht AP Weight AP	Distanzsteckbleche Washers
AP 4	2.061 + AP 4	205.108.000	Standard 4 NbV	51,5	2,65 kg	DS-4-0,5 DS-4-1,0 238.023.000 238.023.001
	4.061 + AP 4	200.055.000	Standard 4 NbV	55,0		
	4.061 HT + AP 4	200.008.009	Standard 4 NbV	55,0		
	4.461 + AP 4	201.038.001	Standard 4 NbV	55,0 - 57,0		
	4.0784 + AP 4	200.016.001	Standard 4 NbV	55,0		
	4.0784 P + AP 4	200.016.004	Standard 4 NbV	55,0		
	PR 2.061 + AP 4	205.075.003	PR 4 NbV	51,5		
	PR 4.061 + AP 4	200.104.001	PR 4 NbV	55,0		
	PR 4.461 + AP 4	200.118.001	PR 4 NbV	55,0 - 57,0		
	PR 4.0784 + AP 4	200.111.001	PR 4 NbV	55,0		
	PR 4.0784 P + AP 4	200.067.003	PR 4 NbV	55,0		
	2.062 + AP 4	205.066.004	Standard 5 NbV	51,5		
	4.062 + AP 4	200.076.000	Standard 5 NbV	56,0		
	4.062 HT + AP 4	200.009.024	Standard 5 NbV	56,0		
	4.462 + AP 4	201.039.001	Standard 5 NbV	56,0 - 60,0		
	4.079 + AP 4	201.015.000	Standard 5 NbV	59,5		
	4.079 P + AP 4	200.018.004	Standard 5 NbV	59,5		
	PR 2.062 + AP 4	205.076.001	PR 5 NbV	51,5		
	PR 4.062 + AP 4	200.105.001	PR 5 NbV	56,0		
	PR 4.462 + AP 4	200.119.001	PR 5 NbV	56,0 - 60,0		
PR 4.079 + AP 4	200.112.001	PR 5 NbV	59,5			
PR 4.079 P + AP 4	200.154.003	PR 5 NbV	59,5			



WINKEL-Rollen | WINKEL Bearings

AP 6

Artikel-Nr. 212.008.000
Article no.

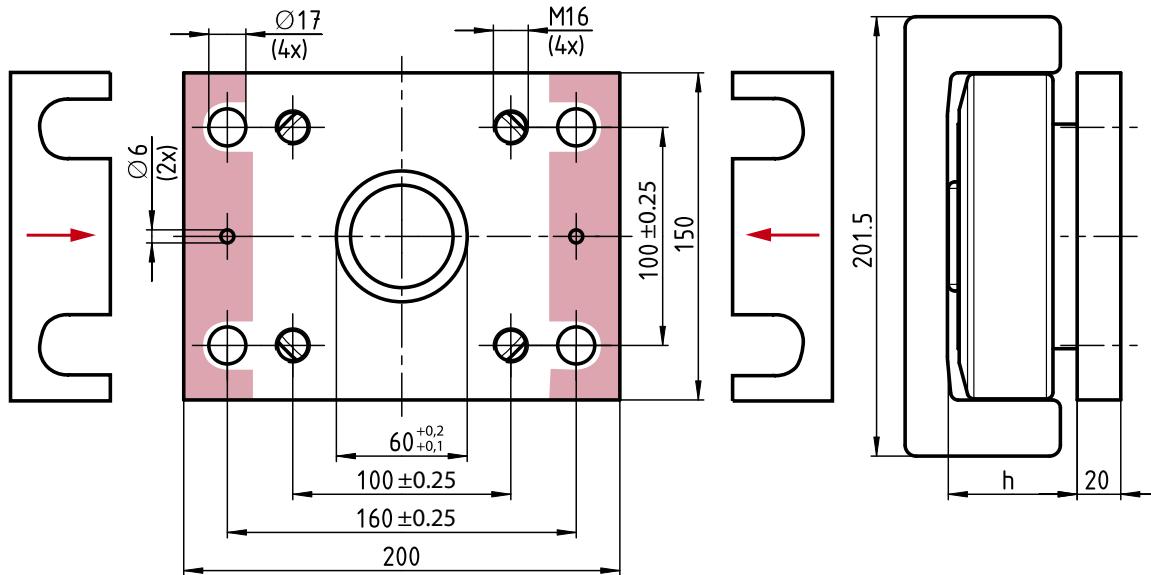

Typ Type	WINKEL-Rolle mit AP WINKEL Bearing with AP	Artikel-Nr. Article no.	Profil Profile	h [mm]	Gewicht AP Weight AP	Distanzsteckbleche Washers
AP 6	2.063 + AP 6	205.067.002	Standard 6 NbV	54,0	4,0 kg	DS-6-0,5 DS-6-1,0 238.024.000 238.024.001
	4.063 + AP 6	200.056.000	Standard 6 NbV	58,5		
	4.063 HT + AP 6	200.010.036	Standard 6 NbV	58,5		
	4.463 + AP 6	201.040.001	Standard 6 NbV	58,5 - 62,5		
	4.080 + AP 6	200.019.003	Standard 6 NbV	69,0		
	4.080 P + AP 6	201.016.000	Standard 6 NbV	62,0		
	PR 2.063 + AP 6	205.077.001	PR 6 NbV	54,0		
	PR 4.063 + AP 6	200.106.002	PR 6 NbV	58,5		
	PR 4.463 + AP 6	200.120.001	PR 6 NbV	58,5 - 62,5		
	PR 4.080 + AP 6	200.113.001	PR 6 NbV	69,0		
PR 4.080 P + AP 6	200.155.001	PR 6 NbV	62,0			