

- | | | | |
|---|--|--|--|
| <ul style="list-style-type: none"> • Platform bracket kit for 9301-E/9308-E/7957 • 4 bottom and 2 side mount options • Unhanded brackets • Fixing hardware included for 9301-E/9308-E • HAZ - 12 hours salt spray test | <ul style="list-style-type: none"> • Kit d'équerres pour 9301-E/9308-E/7957 • 4 options de montage sur plan horizontal et 2 options de montage sous plateau • Équerres convenant indifféremment à gauche ou à droite • Livré avec visserie de montage pour 9301-E/9308-E • HAZ - 12 heures de tenue au brouillard salin | <ul style="list-style-type: none"> • Plattformwinkelsatz für 9301-E/9308-E/7957 • Montagemöglichkeiten: 4 unten und 2 seitlich • Seitenneutrale Winkel • Befestigungselemente inbegriffen für 9301-E/9308-E • HAZ - 12 Stunden Salzsprühstest | |
|---|--|--|--|

634xx	W (kg)
HAZ63412	1.35
HAZ63416	1.77
HAZ63422	2.19
HAZ63428	3.15

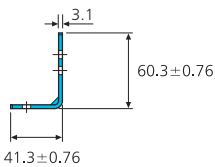
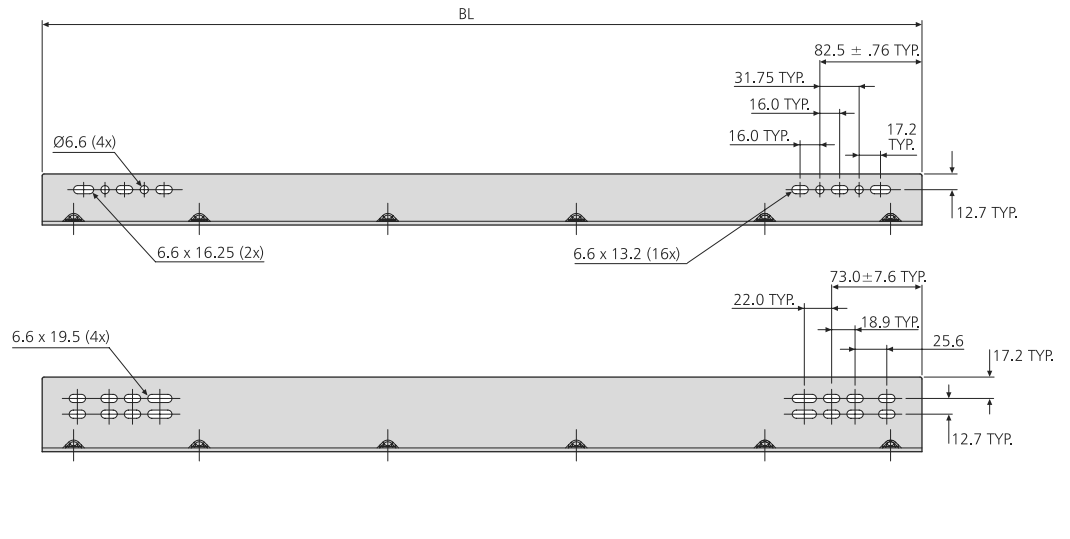

- | | | |
|--|--|--|
| <p>Bracket lengths (BL):
305mm, 406mm, 559mm, 711mm</p> <p>Kit includes:
2 x brackets
4 x 6.4 x 15.9 hex head screws
4 x 6.4 hex head nuts and lock washers</p> <p>Four bracket lengths can be used, either individually or in combination, to cover all slide lengths. See chart to determine number of bracket kits required.</p> <p>The fixings included will not fit the 7957 slide. We recommend using M6 screws, or order a fixing kit from Accuride, order code 22409611.</p> | <p>Longueur d'équerre (BL):
305mm, 406mm, 559mm, 711mm</p> <p>Le kit comprend:
2 équerres
4 vis à tête hexagonale de 6,4 x 15,9
4 écrous à tête hexagonale de 6,4 et rondelles d'arrêt</p> <p>On peut utiliser des équerres en quatre longueurs différentes, soit individuellement soit en combinaison pour convenir à toutes les longueurs de glissière. Pour déterminer le nombre de kits d'équerres requis, voir le tableau.</p> <p>Les vis de fixation fournies avec le kit d'équerres ne conviennent pas à la glissière 7597. Nous préconisons d'utiliser des vis M6 tête fraisée ou de commander un kit Accuride de fixations, référence 22409611.</p> | <p>Winkellängen (BL):
305mm, 406mm, 559mm, 711mm</p> <p>Bausatz besteht aus:
2 x Winkel
4 x 6,4 x 15,9 Sechskantkopfschrauben
4 x 6,4 Sechskantmuttern und Sicherungsscheiben</p> <p>Vier Winkellängen können benutzt werden, entweder individuell oder kombiniert, um sämtliche Schienenlängen abzudecken. Zur Ermittlung der Anzahl benötigter Winkelbausätze siehe nachstehende Tabelle.</p> <p>Die beigelegten Schrauben passen nicht zur Schiene 7957. Wir empfehlen dazu die M6 Senkkopfschraube, oder bestellen Sie den Befestigungssatz von Accuride mit der Bestell-Nr. 22409611.</p> |
|--|--|--|

S = Side-Mount

S = Sous plateau

S = Seitenmontage

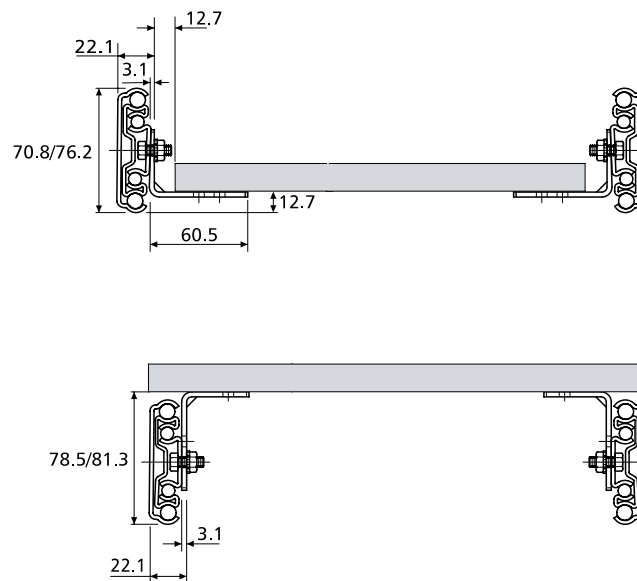

9301-E/9308-E	HAZ63412	HAZ63416	HAZ63422	HAZ63428
	S	S	S	S
930x-0012-E	1	-	-	-
930x-0014-E	1	-	-	-
930x-0016-E	-	1	-	-
930x-0018-E	-	1	-	-
930x-0020-E	-	1	-	-
930x-0022-E	-	-	1	-
930x-0024-E	-	-	1	-
930x-0026-E	-	-	1	-
930x-0028-E	-	-	-	1
930x-0030-E	-	-	-	1
930x-0032-E	-	-	-	1
930x-0034-E	2	-	-	-
930x-0036-E	2	-	-	-
9301-0040-E	1	-	1	-
9308-0040-E	1	-	1	-
9301-0042-E	1	-	-	1
9308-0042-E	1	-	-	1
9301-0044-E	1	-	1	-
9308-0044-E	1	-	-	1
9301-0048-E	1	-	-	1
9308-0048-E	1	-	-	1
9301-0054-E	-	-	2	-
9308-0054-E	-	-	2	-
9301-0060-E	-	-	1	1
9308-0060-E	-	-	1	1

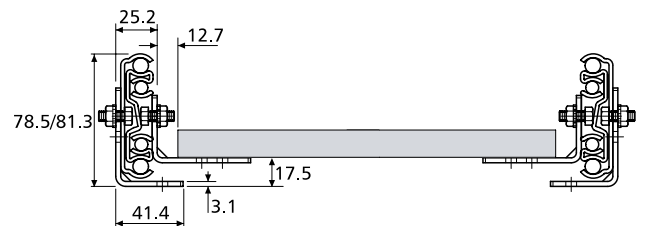
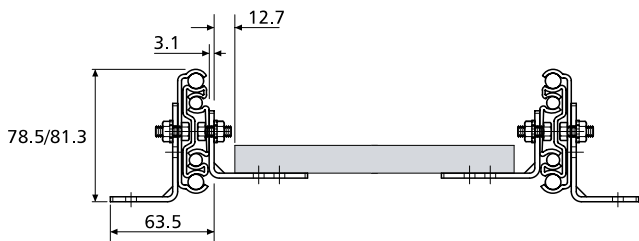
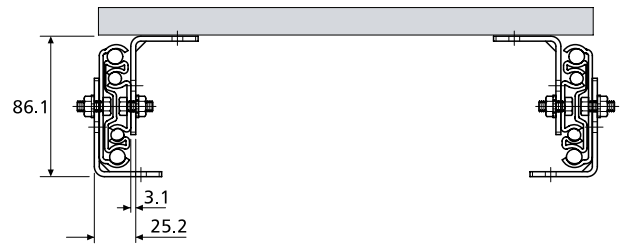
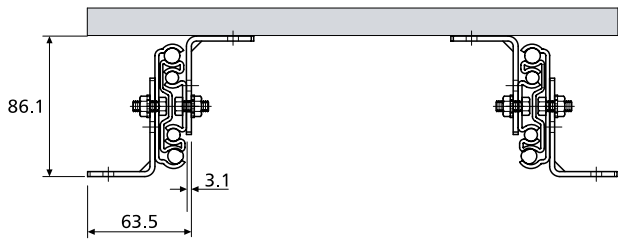
B = Bottom-Mount
B = Sur plan horizontal
B = Montage unten

9301-E/9308-E	HAZ63412	HAZ63416	HAZ63422	HAZ63428
	B	B	B	B
930x-0012-E	2	-	-	-
930x-0014-E	2	-	-	-
930x-0016-E	-	2	-	-
930x-0018-E	-	2	-	-
930x-0020-E	-	2	-	-
930x-0022-E	-	-	2	-
930x-0024-E	-	-	2	-
930x-0026-E	-	-	2	-
930x-0028-E	-	-	-	2
930x-0030-E	-	-	-	2
930x-0032-E	-	-	-	2
930x-0034-E	4	-	-	-
930x-0036-E	4	-	-	-
9301-0040-E	2	-	2	-
9308-0040-E	3	-	1	-
9301-0042-E	2	-	1	1
9308-0042-E	3	-	-	1
9301-0044-E	2	-	2	-
9308-0044-E	3	-	-	1
9301-0048-E	2	-	-	2
9308-0048-E	3	-	-	1
9301-0054-E	-	1	3	-
9308-0054-E	1	1	2	-
9301-0060-E	-	-	2	2
9308-0060-E	-	-	3	1

	IMHAZ9301/HAZ9308-0012		IMHAZ9301-0034
	OMHAZ9301/HAZ9308-0012		IMHAZ9308-0034
	IMHAZ9301/HAZ9308-0014		OMHAZ9301/HAZ9308-0034
	OMHAZ9301/HAZ9308-0014		IMHAZ9301/HAZ9308-0036
	IMHAZ9301/HAZ9308-0016		OMHAZ9301/HAZ9308-0036
	OMHAZ9301/HAZ9308-0016		IMHAZ9301/HAZ9308-0040
	IMHAZ9301/HAZ9308-0018		OMHAZ9301-0040
	OMHAZ9301/HAZ9308-0018		OMHAZ9308-0040
	IMHAZ9301/HAZ9308-0020		IMHAZ9301/HAZ9308-0042
	OMHAZ9301/HAZ9308-0020		OMHAZ9301-0042
	IMHAZ9301/HAZ9308-0022		OMHAZ9308-0042
	OMHAZ9301/HAZ9308-0022		IMHAZ9301-0044
	IMHAZ9301/HAZ9308-0024		OMHAZ9301-0044
	OMHAZ9301/HAZ9308-0024		IMHAZ9301/HAZ9308-0048
	IMHAZ9301/HAZ9308-0026		OMHAZ9301-0048
	OMHAZ9301/HAZ9308-0026		OMHAZ9308-0048
	IMHAZ9301/HAZ9308-0028		OMHAZ9301-0054
	OMHAZ9301/HAZ9308-0028		IMHAZ9301/HAZ9308-0054
	IMHAZ9301/HAZ9308-0030		OMHAZ9308-0054
	OMHAZ9301/HAZ9308-0030		IMHAZ9301/HAZ9308-0060
	IMHAZ9301/HAZ9308-0032		OMHAZ9301-0060
	OMHAZ9301/HAZ9308-0032		OMHAZ9308-0060

7957	HAZ63412-305mm		HAZ63416-406mm		HAZ63422-559mm		HAZ63428-711mm	
	S	B	S	B	S	B	S	B
7957-0012	1	2	-	-	-	-	-	-
7957-0014	1	2	-	-	-	-	-	-
7957-0016	-	-	1	2	-	-	-	-
7957-0018	-	-	1	2	-	-	-	-
7957-0020	-	-	1	2	-	-	-	-
7957-0022	-	-	-	-	1	2	-	-
7957-0024	-	-	-	-	1	2	-	-
7957-0026	-	-	-	-	1	2	-	-
7957-0028	-	-	-	-	-	-	1	2
7957-0030	-	-	-	-	-	-	1	2
7957-0032	-	-	-	-	-	-	1	2
7957-0034	-	2	-	-	-	-	1	1
7957-0036	1	3	1	1	-	-	-	-

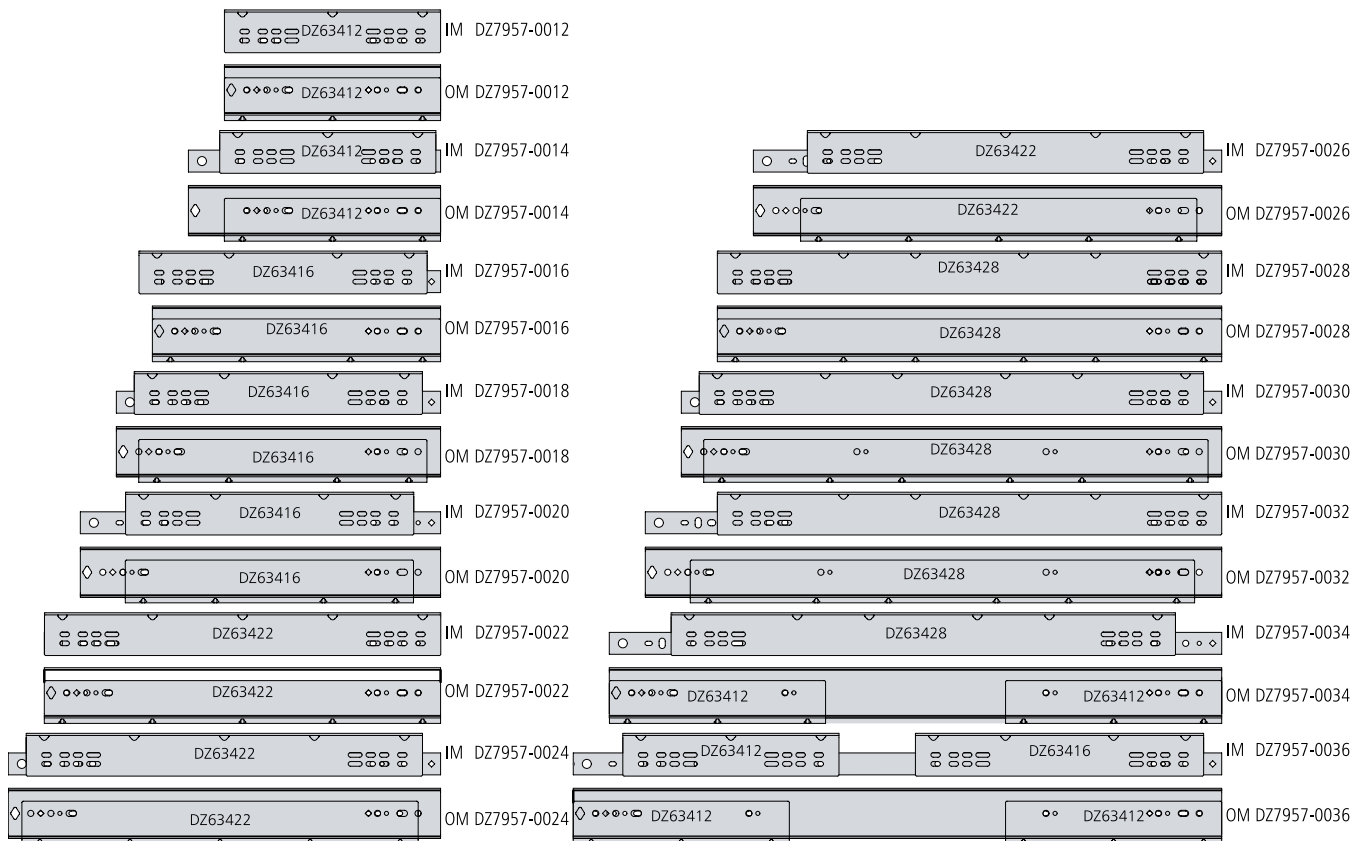
Notes:

- Customer supplies hardware to mount brackets to base and/or platform/drawer
- Cold rolled steel
- Dimensions for reference only
- Please refer to 2D CAD drawings for dimensional tolerances

Notes:

- Visserie pour monter les équerres sur la base et/ou le plateau/le tiroir non fournie
- Acier laminé à froid
- Dimensions indiquées à titre de référence seulement
- Pour les tolérances dimensionnelles, veuillez vous reporter à nos plans 2D

Hinweise:

- Kunde stellt Kleinteile zur Montage von Winkeln an Basis und/oder Plattform/Lade
- Kaltgewalzter Stahl
- Abmessungen nur orientierungshalber gezeigt
- Bitte beachten Sie die 2D-CAD-Zeichnung wegen Abmessungstoleranzen